



EXCELLENCE REDEFINED

OFFICIAL SHOW GUIDE

OCTOBER 14 & 15 2018
GAYLORD NATIONAL RESORT
OXON HILL, MD

CALL 844-285-1103 TO REGISTER
OR VISIT WWW.SELECTJEWELRYSHOW.COM

FOREVERMARK



THE DIAMOND. THE PROMISE.



H. j. Namdar
Diamonds

head turners...

DC#12



JEWELS by JACOB
FINE JEWELRY

Office:

15 West 47th Street, Suite 603 New York, NY 10036

Tel: 212-391-5900 • Fax: 212-391-4948

Email: Moses@jbjacob.com

www.jbjacob.com

Showroom:

32 West 47th Street, Booth #7 New York, NY 10036

Tel: 212-391-8700 • Fax: 212-785-9797

Email: Sammy@jbjacob.com





ASK FOR OUR NEW LOOK BOOK

 **DINARO** *Creations*

WWW.DINAROCREATIONS.COM

98 Cuttermill Road, Suite 396N • Great Neck, NY 11021

P: 516-439-5200 F: 516-439-5206

Email: dinarocreations@gmail.com

WELCOME



We are pleased to bring the Select Jewelry Show to the Washington DC area at the Gaylord National Resort in Oxon Hill, MD. Started 10 years ago, Select Shows bring many of the industry's most popular jewelry brands to you in a relaxed yet luxurious setting.

Every day of the show the wonderful staff at the Gaylord National will provide a continental breakfast to start and a scrumptious buffet lunch to follow. On Sunday evening don't miss the social mixer at Pose on the Gaylord observation deck from 6:30pm to 8:30pm.

We are pleased to be able to bring Susan Arlin of Brilliant Performance Group LLC and Barbara Palumbo of Adornmentality, for their amazing insight on fine tuning your business. See page 8 for details.

A signature of the Select show is the buyers raffle worth up to \$10,000. Don't miss the afternoon raffles on Sunday and Monday for the free money to be given. You will have several different ways to earn tickets for chances to win. **See page 10.**

Please mark your calendar to be a part of this tremendous buying event.

October 14th and 15th, 2018 at the **Gaylord National Resort in Oxon Hill, MD.**

To pre-register please call **844-285-1103** or visit **www.SelectJewelryShow.com** for more information.

The Select Team

SELECT JEWELRY SHOW

64 W 48th St, Suite 1005, New York, NY 10036

CALL 844-285-1103 TO REGISTER
OR VISIT WWW.SELECTJEWELRYSHOW.COM

STACKABLE FASHION RINGS

by VARIETY GEM

Since 1984



Booth #28

 VARIETY GEM Co., INC.

800-735-4367 * WWW.VARIETYGEM.COM

TABLE OF CONTENTS



Welcome Letter	6
Schedule	10, 11
Exhibitor List	12
Floor Plan	14, 15
Exhibitor Profiles	16
Raffle Details	60
Show Specials	66, 67

ADVERTISERS INDEX

Aiya Designs	9, 18, 65
Beverley K	22
Costar Imports	24
DA Gold	26
Daniel Dilman	28
Dinaro Creations	4, 5
Frederic Sage	34
HJ Namdar	2
Imperial Pearl	38
Jewels by Jacob	3
Lafonn	42
Makur	46
Rembrandt Charms	13, 56
Royal Jewelry	58
Shieler Trading Corp	64
Variety Gems	7, 55, 62

Gaylord National Resort

201 Waterfront Street
Oxon Hill, MD, 20745

Phone: 301-965-4000

(Call for directions and other hotel information)

PiYaRo

By Aiya Designs



PRB4019

JCK JEWELERS' CHOICE AWARDS
2017 FINALIST



PRB4033

JCK JEWELERS' CHOICE AWARDS
2018 FINALIST



PR2452



PR2454

*Hold & Behold
Excellence*

Dollar for Dollar Stock Balancing Across All Our Lines

www.PiYaRo.com
sales@AiyaDesigns.com | 888-427-8886

SCHEDULE DAY 1

Sunday, October 14, 2018

8:30 – 9:45am Continental Breakfast served in **Ballroom Foyer**

9:00 – 9:45am Monday Morning Education:
Social Media Effectiveness

Join Barbara to discover what is involved in taking your store's social media up a notch to increase its effectiveness.

10:00am – 6:00pm Show Floor Open

12:30pm – 2:00pm Lunch served in the **Ballroom Foyer**

3:00pm – Raffle Drawing for at show purchasing credits worth \$ thousands. Collect raffle tickets based on purchases until 2:30pm, drawing at 3:00pm. You must be present to win. Raffle details below.

6:30 – 8:30pm Cocktail Party. Enjoy cocktails and hors d'oeuvres with your Select Show friends at **Pose**.



Barbara Palumbo



Sponsored by-



RAFFLE DETAILS!

Don't forget to participate in our 2018 Buyer Raffle worth up to \$10,000 in At-Show Purchasing Credits and Merchandise!

Be sure to get a copy of Every Purchase Order you place at the show to get more raffle tickets.

DRAWING TIME!

3:00 PM – Raffle Drawing for At-Show Purchasing Credits worth thousands of \$\$ on the Show Floor. Collect raffle tickets based on purchases until 2:30PM for drawings on Sunday and Monday at 3:00PM. You must be present to win.

Remember, you must be present to win, but if you have non-winning tickets on one day, they will be included again in the following drawings.

SCHEDULE DAY 2



Monday, October 15, 2018

8:30 – 9:45am Continental Breakfast served in **Ballroom Foyer**

9:00 – 9:45am Sunday Morning Education:
Compensation Conundrum

Join us for an exciting and thought-provoking session that tackles the complex subject of compensation in today's ever-changing world. How much should you pay? Salary or hourly? What about commission? Walk away with a strategy for determining the best compensation structure for your team to attract and retain the top talent in your market.



Susan Arlin

10:00am – 5:00pm Show Floor Open

12:30pm – 2:00pm Lunch served in the **Ballroom Foyer**

3:00pm – Raffle Drawing for at show purchasing credits worth \$ thousands. Collect raffle tickets based on purchases until 2:30pm, drawing at 3:00pm. You must be present to win. Raffle details below.

Thank you, travel safely.

RAFFLE DETAILS!

The Following are Aggregate Purchase Dollar Incentives:

If you write and present \$5,000 or over in collective Purchase Orders at the show, you get one more extra raffle ticket;

\$10,000 or over gets you 2 more extra raffle tickets;

\$15,000 or over, 3 more extra raffle tickets;

\$20,000 or over, 4 more extra raffle tickets;

\$25,000 or over, 5 more extra raffle tickets;

\$35,000 or over, 7 more extra raffle tickets;

\$50,000 or over, 10 more extra raffle tickets;

\$100,000 or over, 20 more extra raffle tickets.



EXHIBITORS



A&D Gem/DVANI.....	33	KC Designs	205
ADA Gems Corp	209	KGM	19
Afarin	31	Lafonn.....	27
Aiya Designs.....	104	Leslie's Brand/ Quality Gold	110
Alisa	308	Lexi Mazz Designs	207
Armand Jacoby	105	Lika Behar	16
Artistry Ltd.....	410	Luca Lorenzini.....	405
Asher	106	Makur.....	401
Baggins.....	108	Marathon/LeStage.....	21
Bassali.....	29	Marika Desert Gold	109
Beverly K	101	Mastoloni.....	34
BM Designs	402	Mazza & Co.	206
CG Creations.....	11	MCE.....	301
Color Merchants	14	Meira T	202
Color Source.....	403	Midas chain	32
Costar Imports.....	26	Michael Michaud Design.....	302A
Crown Ring.....	409	MWI.....	204
DA Gold	408	Nava Dee	20
Daniel Dilman	201	Nina Nguyen	307
David Connolly/Jabel.....	402A	Norman Covan	305
Diabella	13	Novell	23
Dilamani	10	Officina Bernardi.....	203
Doves by Doron Paloma.....	36	Paragon Couture Group.....	102
E. L. Designs.....	303	Paragon Pearl	201
Elite Designs.....	310	Parle.....	30
Fitzgerald Imports	103	PeJay Creations.....	309
Four Seasons Designs	302A	Phillip Gavriel.....	15
Frederic Sage	35	Qayten.....	107
Gemoro	25	Reko.....	308A
Graymoor Lane Designs.....	410	Rembrandt Charms	17
Haridra Jewelry.....	24	Royal Chain.....	15
Heera Moti	407	Royal Jewelry.....	18
Henderson Collection.....	405	Samuel B.	408A
HJ Namdar	210	Shefi Diamonds	302
Imperial pearl	22	Shieler.....	208
Jewels by Jacob	12	Variety Gem.....	28
Kabana	102		

Rembrandt Charms®

Precious charms for precious memories.

Thousands of
Hand-Crafted Charms
in Gold and Silver.

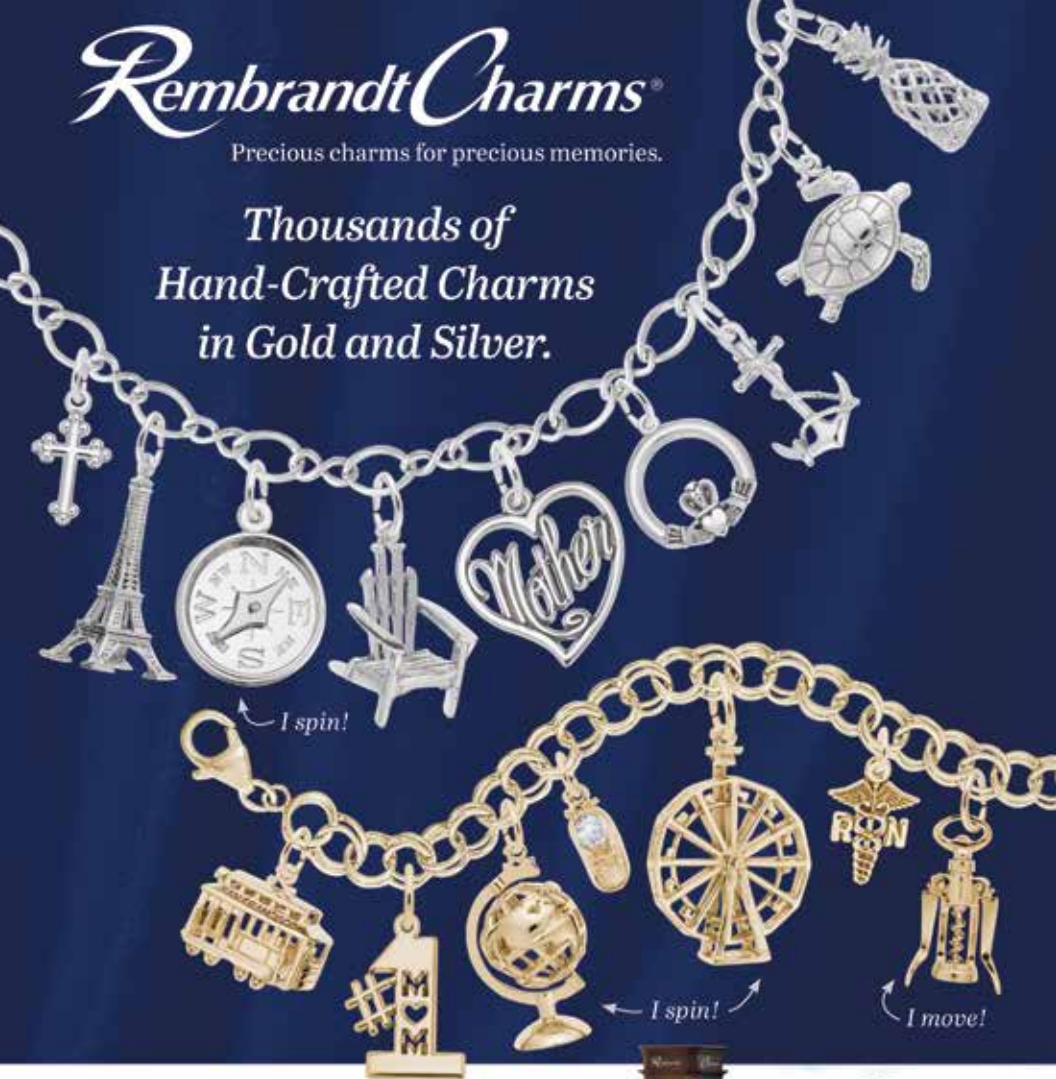

What Retailers Are Saying

"Rembrandt's wide assortment of affordable, high quality charms has helped us capture the under \$200 price point without compromising the quality of our merchandise."

- Jim Brusilovsky, Mark's Jewelers



Contact us for more info on our Business Building Charm Program!

Orders@RembrandtCharms.com • p.800-828-7840 • f.800-828-7811



Lifetime
Warranty



Handcrafted in
USA & Canada



Thousands of Charms
In Gold and Silver

FLOOR PLAN

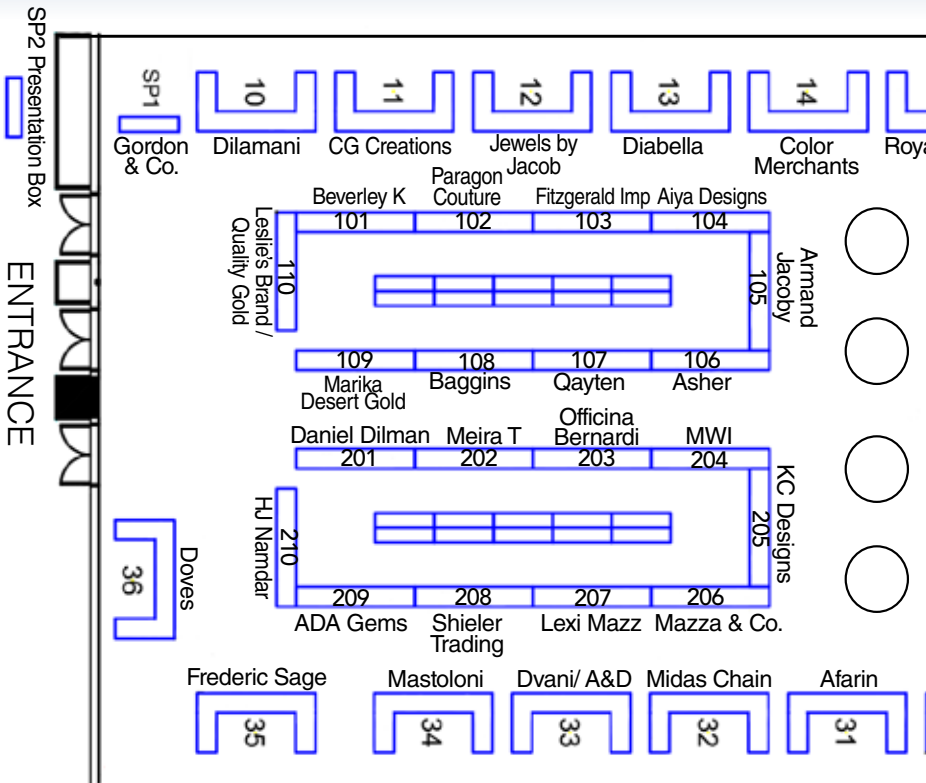

OCTOBER 14 & 15 2018
 GAYLORD NATIONAL RESORT
 OXON HILL, MD

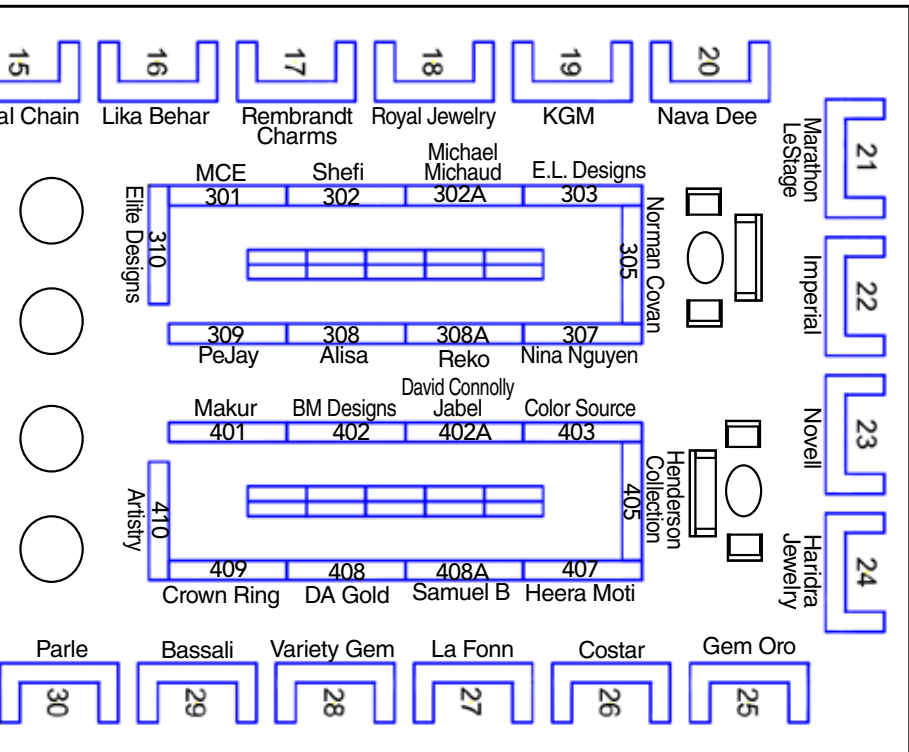

EXHIBITORS

A&D Gem/DVANI



Booth 33

38 West 48th St (5th fl)
New York, NY 10036
212-944-2700
www.jewelsbyad.com

Dvani provides women fashion-forward ability to accessorize with genuine gemstone and precious jewelry at accessible price points.

Jason Kordvani
jason@jewelsbyad.com

D V A N I
by **A&D Gem Corp.**

ADA Gems Corp/ Mordechai Collection



Booth 209

50 West 47th St. #1717
New York, NY 10036
212-719-0190 Fax: 212-719-0692
www.mordechaicollection.com

Diamond importer and jewelry manufacturers for over 28 years. Servicing the USA, US Virgin Islands, Canada and Southeast Asia. Diamond Bracelets, necklaces, hoops and emerald cut bands. Additionally we have just launched our Italian hand-made jewelry.

Daniel Mordechai
adagemsny@aol.com



Afarin

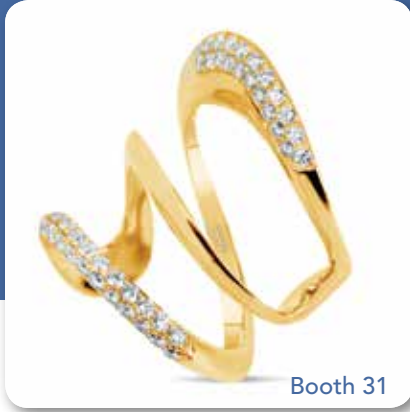

Booth 31

98 Cuttermill Rd., Ste. 410
Great Neck, NY 11021
212-944-0188 Fax: 212-944-2774
www.apafarin.com

Afarin is a direct manufacturer of exquisite luxury jewelry at affordable pricing while implementing superior craftsmanship in every design.

Jason Hakimi
jason@apafarin.com

afarin

Aiya Designs

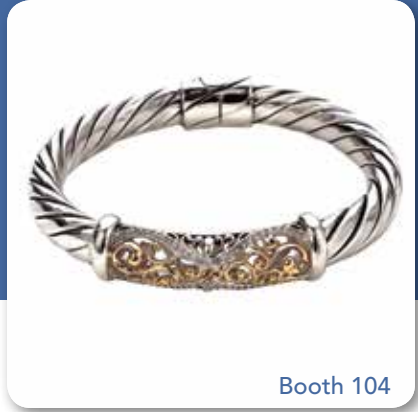

Booth 104

152 Prospect Pl
Alpharetta, GA 30005
888-427-8886
www.aiyadesigns.com

Aiya Designs is a fourth-generation manufacturer and quality is our signature. We have guaranteed sales programs in diamond fashion, Italian gold and silver, lab created stones, or LED lights. We offer dollar for dollar stock balance across it all.

Check us out on
www.Aiyadesigns.com
www.piyaro.com
www.lustour.com
www.jewelryled.com

Sunny
sales@aiyadesigns.com

AIYA DESIGNS

Jewelry LED

Let Us Light Up Your Sales!



Multi-Directional
5 LED Stand



Par30



Par38



MR16



Par16



GU10



E12
Chandelier

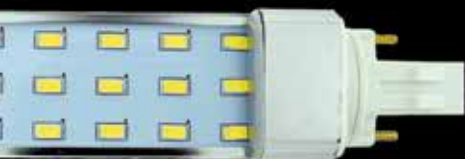

GX23/G24



T8 Tubes (2ft - 5ft)



LED Strips (1ft - 5.5ft)

Call for a free lighting consultation!

www.JewelryLED.com
sales@JewelryLED.com | 888-427-8886

EXHIBITORS



Alisa



Booth 308

522 US HWY 9
Manalapan, NJ 07726
888-253-6600
www.alisadesigns.com

Alisa's fine jewelry products in silver and silver with 18K gold, mostly priced at \$200-\$800 retail, are perfect for today's casual lifestyles. Made in Italy. Displays and marketing support provided.

Fred Morgan
Lisa Morgan
alisa@alisedesigns.com

Alisa

... the essence of Italian creativity

Armand Jacoby



Booth 105

731 Sansom St.
Philadelphia, PA 19106
215-922-0976 Fax: 215-922-3385
www.armandjacoby.com

For the past 60 years, Armand Jacoby has been a leader in jewelry design and manufacturing. One of the first to offer branded jewelry, today we continue to shape the industry by uniting old world craftsmanship with modern technology to produce America's finest 18kt and platinum diamond and colored stone jewelry.

Wayne Kivitz
armandjacoby@aol.com



EXHIBITORS

Artistry Ltd.

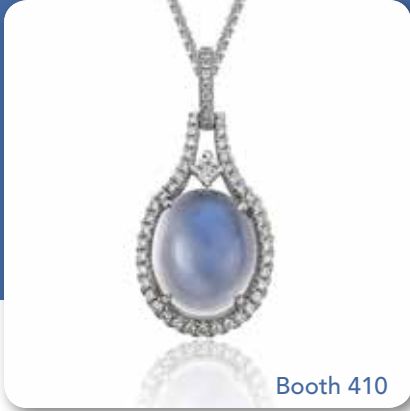

8272 Lincoln Ave.
Skokie, IL 60077
847-674-3250 Fax: 847-674-3208
www.artistrylimited.com

Refined interpretations of the latest trends as well as jewelry classics. Artistry offers beautifully-crafted collections in diamond, color, gold and sterling silver. Accessible price points, excellent profit potential and same day shipping.

Artistry's multi-generational ownership and team take pride in offering our customers a steady stream of outstanding designs of exceptional quality, without compromise. Call today for an Artistry catalog.

Susan Klemt Williams
susan@artistrylimited.com

ARTISTRY, Ltd.

Asher Jewelry

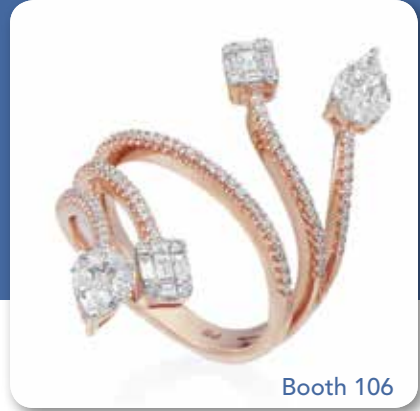

175 Great Neck Rd., Ste. 201
Great Neck, NY 11021
212-302-6233 x 202
www.asherjewelry.com

For over 35 years, Asher has been a leading manufacturer of Designer Jewelry for independent retailers on a global level. Specializing in the latest jewelry trends, Asher features the most complete collection of the hottest styles without the inflated pricing throughout the jewelry industry.

Fred Asher
Fred@asherjewelry.com

Asher

Baggins

Bassali



Booth 108

Booth 29

510 W. Sixth St., Ste. 416
 Los Angeles, CA 90014
 213-624-2277 Fax: 213-624-2278
www.BagginsPearls.com

98 Cuttermill Rd.
 Great Neck, NY 11021
 516-466-2045 Fax: 516-466-2089
www.bassalijewelry.com

Baggins is a supplier of innovative, fine quality Akoya, South Sea, and Tahitian Cultured Pearl jewelry, loose pearls and strands.

Unique. Affordable. Sellable Bassali Jewelry prides themselves on their unique and eclectic line of 14 and 18 Karat jewelry that is ALSO sell-able. Efi Bassali has created a line with a delicate, minimalist aesthetic all hand-set in 14 Karat Gold. Bassali Jewelry's up-to-date Diamond Essentials and Band Classics have been the rage at countless retailers. Visit us at Select Jewelry Shows to see why!

Anil Maloo
bagginsinc@sbcglobal.net

Efi Bassali
efi@bassalijewelry.com



A woman in a white wedding dress is shown from the back, walking down a staircase with an ornate metal railing. The dress is strapless and has a full, ruffled skirt. In the upper right corner, there is an inset image of a large, ornate diamond ring with a central round diamond and several side stones.

BEVERLEY K
As Unique as Your Love

16 Design Awards Since 2015

SALON #101

Make a Show Appointment to View the Line
619.465.4789 | info@beverleyk.com | www.BeverleyK.com

EXHIBITORS



Beverley K

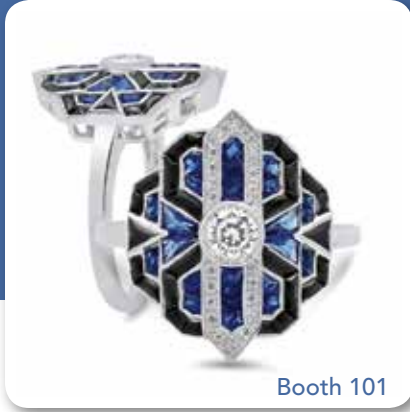

Booth 101

7777 Alvarado Rd., #322
La Mesa, CA 91942
619-465-4789 Fax: 619-465-7603
www.beverleyk.com

Beverley K, a premier leader in vintage-style jewelry with 16 design awards, is renowned for timeless styles, intricate details, French cut color stones and hand-craftsmanship. Bridal and fashion collections include vintage, Art Deco, floral, stackables and more.

Harsh Sacheti
harsh@beverleyk.com

BM Designs



Booth 402

21W 47th St
New York, NY 10036
212-944-9692

With over 35 years of experience, BM Designs provides the highest level of quality customer service with consistency. Our diamonds and gemstones are hand set in 14kt and 18kt gold.

Ben & Varda
benmdesigns@gmail.com

BEVERLEY K

BM DESIGNS



COSTAR

FOR YOUR PRECIOUS MOMENTS...

Stackable WEDDING BANDS



www.costarimports.com

Toll Free: 888.726.7827

Custom CAD Available



CG Creations



Booth 11

PO Box 1001
 Pearl River, NY 10965
 800-431-1606 Fax: 845-735-1798
www.cgcreations.com

We offer fashion-forward, trendy, sought-after jewelry, complimented with basic staples in 14K gold and sterling silver from Italy. CG Creations markets under the brands Wind & Fire, Zable, Stellar White and Gold Horizons.

Lance Fiasconaro
sales@cgcreations.com



Color Merchants/Brevani

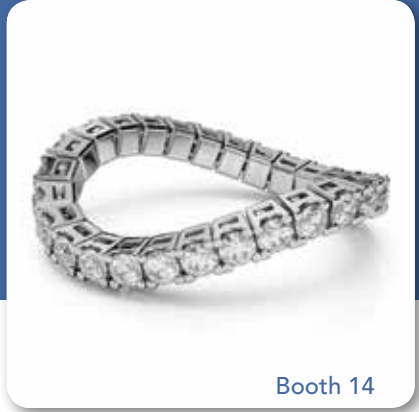

Booth 14

6 East 45th St.
 New York, NY 10017
 212-682-4788 Fax: 212-682-1306
<http://brevani.com>
www.colormerchants.com

With more than 30 years of experience, this family run second generation company has been a leading supplier of wholesale diamond and gemstone jewelry within the industry. Known for outstanding quality and unmatched customer service, Color Merchants continues to provide highly saleable merchandise at competitive pricing.

Allison Peck
Allison@brevani.com





JCK LUXURY
LAS VEGAS SALON LUX 1021

SELECT
JEWELRY SHOW

JA NEW YORK
BOOTH #1349

EXHIBITORS



Color Source Gems



Booth 403

2 West 46th St., Ste 802
New York, NY 10036
212-262-2333 Fax: 212-221-6321
www.colorsourcgems.com

Color Source Gems is your source for color! Featuring loose and mounted emerald, ruby, sapphire, spinel and garnets; we've got what you need in color.

Moshe Chalchinsky
moshe@colorsourcgems.com

Rachel Chalchinsky
Rachel@colorsourcgems.com



Costar Imports



Booth 26

800 Airport Boulevard, Ste. 304
Burlingame, CA 94010
650-389-6969 Fax: 888-726-7827
www.costarimports.com

Costar Imports has been serving fine jewelry independents in the United States since 1988. Quality, style, superior craftsmanship, and value are at the heart of all Costar products and our attitude to your success leads to an everlasting partnership.

Avinash Bajaj
info@costarimports.com



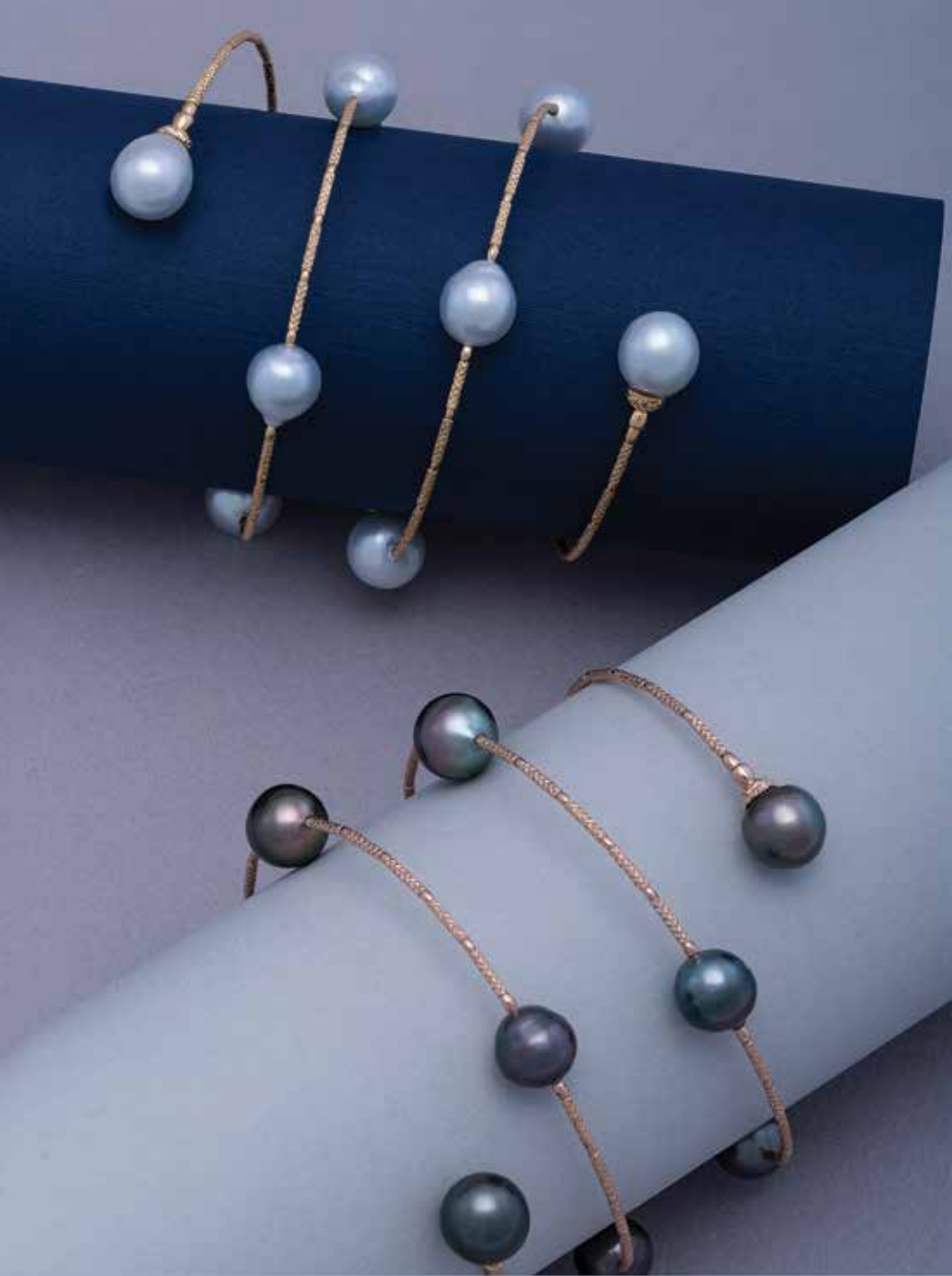

DANIEL DILMAN

We have crafted a line of standout jewelry that speaks to the simple yet sophisticated woman. Our very popular wrap bracelets here in 18k gold with South Sea and Tahitian pearls. SRP: \$1,300 (800) 732-7522

info@DanielDilman.com

EXHIBITORS



CrownRing

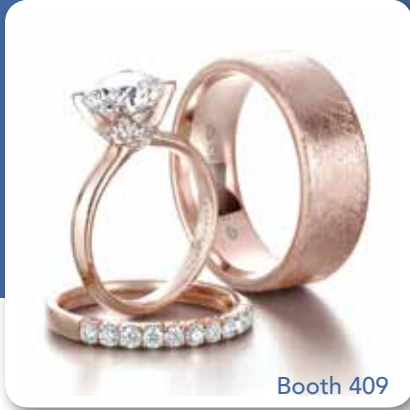

Booth 409

5565 Cote-De-Liesse
Montreal, Quebec
H4P1A1, Canada
514-381-1589
www.crownring.com

The CrownRing Bridal House, a name that has come to represent excellence in bridal jewellery. Under this label rests five defining brands; CrownRing, Carlex, Bleu Royale, Torque and Noam Carver. CrownRing and its divisions continue to lead the pace in the bridal industry by creating award winning and captivating jewelry.

Ilan Dahan
ilan@crowring.com



CROWN RING
BRIDAL HOUSE

DA Gold



Booth 408

2 West 46th St.
New York, NY 10036
212-819-1111 Fax: 212-730-5706
www.dagoldproducts.com

We offer extensive selection of Italian made fashion Jewelry designs. Artful craftsmanship and excellent customer service are the foundation of DA Gold.

Snezana Otonoga
da@dagoldproducts.com



EXHIBITORS

Daniel Dilman



22 W 48th St #204
New York, NY 10036
212-997-2323
www.danieldilman.com

Most celebrated for our signature lariat necklaces starting at just \$1400 SRP. Many of the necklaces are adjustable in length and made to be worn in several ways – and even as bracelets – thanks to the designer’s proprietary clasp. Co-op advertising, extended payment terms, stock balancing, marketing material, incase displays.

Daniel Dilman
info@danieldilman.com



David Connolly Inc./Jabel



1091 Bristol Road
Mountainside, NJ 07092
800-526-4597 Fax: 800-771-7997
www.jabel.com
www.davidconnolly.com

Jabel celebrates 102 years of heirloom quality die struck jewelry, designs include bridal, pendants, earrings, bracelets, rings, & hand engraved jewelry in 14K, 18K, and Platinum. David Connolly’s signature 14K collection of pendants, earrings, rings, bracelets, pins and bridal designs in diamond, gemstone, and pearl. Made in USA.

David Connolly
Info@jabel.com

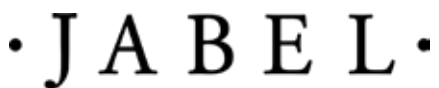

Diabella

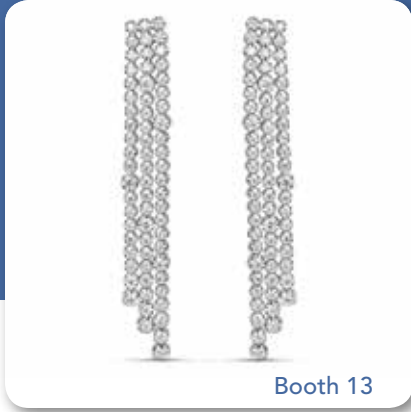

Booth 13

98 Cuttermill Rd., Ste 295N
Great Neck, NY 11021
516-773-3636
www.diabellajewelry.com

Specializing in High Fashion, Classics, Bridal and Wedding bands. Manufacturing in 14kt, 18kt, and platinum and SI1 GH color diamond quality.

Isaak Nassimi
isaak@diabellajewelry.com

Dilamani



Booth 10

98 Cuttermill Rd., Ste 262
Great Neck, NY 11021
516-466-6767 Fax: 516-466-7906
www.Dilamani.com

Your customers will delight in our innovative designs and impeccable craftsmanship, bringing them back time and time again. Our desire is to help you build customer relationships through our beautiful pieces. We've built our business on over three decades of relationships, so we know the power of winning a customer's heart for life.

Elliot Dilamani
sales@dilamani.com

DIABELLA



EXHIBITORS

Doves by Doron Paloma



Booth 36

98 Cuttermill Rd., Ste. 493
Great Neck, NY 11021
888-66-DOVES
www.dovesjewelry.com

Designed as a harmony of nature and art, Doves by Doron Paloma uses natural gemstones set in 18kt gold, with exquisite diamond pave. Doron's journeys and architectural background inspire the color and styling of every work of art, including the art-deco inspired Gatsby collection. Doves continues to be a celebrity favorite on red carpets everywhere.

Doron Hakimian
info@dovesjewelry.com



E.L. Designs by Ed Levin Studio



Booth 303

52 West Main St.
Cambridge, NY 12816
518-677-8595
www.eldesigns.com

E. L. Designs by Ed Levin Jewelry is a leading design studio. American made fashion jewelry for over 70 years. E. L. Designs, led by the visionary and creative talent of Peter Tonjes, produces fashion forward, designs that provide the wearer with a lifetime of inspiration.

Kiki Perkins
kiki@eldesigns.com

Melissa Johnson
melissa@eldesigns.com

Peter Tonjes
peter@eldesigns.com



Elite Designs



Booth 310

424 Sunset Dr
Hallandale, FL 33009
954-455-5353
www.elitedesignsinc.com

18kt gold, diamonds, gems, and ceramic. The latest fashion in fine jewelry design. Quality and service since 1975 It's new - It's now - It's next.

Joseph More
eliteone@bellsouth.net

Fitzgerald Imports



Booth 103

333 Washington St., Ste. #307
Boston, MA 02108
617-367-2233

Fitzgerald Imports carries fine colored gemstones from Alexandrite to Zircon. We have been traveling overseas for over 30 years to find the finest gems at the best prices.

Eric Fitzgerald
fitzgem@comcast.net

ELite
DESIGNS INC.

 **FITZGERALD**
imports



FredericSage.com | 800.651.1810 | #FredericSage

Frederic Sage



Booth 35

98 Cuttermill Rd
Great Neck, NY 11021
516-482-1424
www.fredericsage.com

Frederic Sage "Better" Everyday Diamonds from the Firenze Collection is made with the finest diamonds and available in multiple gold tones. Starting MSRP \$995.

Frederic and Brian Sage
shows@fredericsage.com



GemOro



Booth 25

48 West 48th St., Ste 1102
New York, NY 10036
212-768-8844
www.gemOro.com

World's largest selection of black and white diamond jewelry. Available in matched sets and price points. New collection of petite 18kt white diamond jewelry. Collection of rose gold with brown diamond jewelry. Collection of stackable rings.



EXHIBITORS

Graymoor Lane Designs

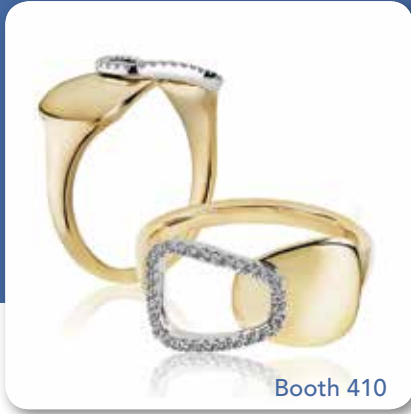

Booth 410

8272 Lincoln Avenue
Skokie, IL 60077
888-674-8340 Fax: 847-674-3208
www.graymoorlanedesigns.com

Graymoor Lane Designs is an exciting new branded collection inspired by Mid-Century Design and a family story spanning four generations. The modern yet timeless collections are perfectly matched to the varied lives of today's modern woman. GLn balances an authentic design aesthetic with contemporary lifestyles at accessible price points.

Susan Klemt Williams
appointments@graymoorlanedesigns.com

Graymoor Lane™
DESIGNS

Haridra by Hari Jewels



Booth 24

62W 47th St. #503
New York, NY 10036
212-354-7550 Fax: 212-643-7570
www.haridrany.com

We at Haridra strive for perfection and innovation. Our high-end line of jewellery shows our keen interest in blending traditional and modern designs to create something new and unique. Visit us once to spellbound and take with a piece of joy and celebration.

Atin Jain
info@haridrany.com

Haridra®
NEW YORK
By Hari Jewels

Heera Moti



Booth 407

15 West 47th St., Ste 808
 New York, NY 10036
 212-764-1600 Fax: 212-764-0007
www.hmijewelry.com

Heera Moti is a premier diamond jewelry manufacturers servicing the finest independent retail jewelers in North America, South America, and Canada. Our focus is to help you grow your business, maximize your sales, and build your brand by providing unparalleled value and quality for an exceptional price, since 1987.

Ishaan Sadhwani
ishaan@hmijewelry.com

HEERA MOTI
 NEW YORK

Henderson Collection



Booth 405

2300 E 7th St. #201
 Charlotte, NC 28204
 800-605-3035 Fax: 704-333-3032
www.wlhlimited.com

18K Venetian and 18K/SS Firenze Enamel bracelets available in any pantone color. All pieces have a lifetime guarantee. Nationally recognized instore event program along with an interactive website.

Lecil Henderson
generalinfo@wlhlimited.com

THE HENDERSON
 COLLECTION *by Lecil*



Foxwoods Aug 19-20 booth 24 • Washington, DC Oct 14-15 booth 22

IMPERIAL®

WE ARE PEARLS

EXHIBITORS



H.J. Namdar



Booth 210

16 West 46th St. 9FL
New York, NY 10036
212-398-9564 Fax: 212-575-1020
www.hjnamdar.com

For over three generations, H.J. Namdar has been known as the industry leader for fine jewelry. Our worldwide reputation for quality, value and integrity is unsurpassed. The H.J. Namdar inspirations emerge from many places, including nature, fashion and the core classic. All our designs have the wear ability to be "everyday" luxury and yet have the "red carpet allure". H.J. Namdar truly stands for luxury that is made affordable for the everyday customer.

Benny Namdar
benny@hjnamdar.com

H.j. Namdar
Diamonds

Imperial Pearl



Booth 22

795 Waterman Ave
East Providence, RI 02914
401-223-4172 Fax: 401-434-0814
www.imperialpearl.com

Imperial is an international jewelry brand with a fierce passion for fine pearls and fresh, innovative design. Offering all varieties of pearl jewelry, strands and programs along with branding, education and marketing. Imperial...we are pearls.

Moe Richard
mjr826@comcast.net

Kathy Grenier
Kathy@imperialpearl.com

IMPERIAL[®]

EXHIBITORS

Jewels by Jacob



Booth 12

15 West 47th St., Ste 603
New York, NY 10036
212-391-8700 Fax: 718-785-9797
www.jbjacob.com

Jewels by Jacob portrays a sense of beauty through its jewelry that you won't find anywhere else. Come and experience the extraordinary at Jewels by Jacob – your imagination will come to life.

Moses Hakimi
Moses@jbjacob.com

Sammy Ghassabian
sammy@jbjacob.com



KC Designs



Booth 205

64 West 48th St. Ste 1005
New York, NY 10036
212-391-8700
www.kcdesignsnyc.com •
Social Media @kcdesignsnyc

KC Designs has become one of the leaders in fine fashion jewelry for over 30 years. Their commitment to producing "Everyday Diamonds" at affordable prices has earned them a reputation of excellence among major brand retailers and fashion authorities alike.

Joe Carullo
joe@kcdesignsnyc.com

KC DESIGNS

EXHIBITORS



KGM



Booth 19

62 West 47th St., #501
New York, NY 10036
212-944-7068
www.kgmind.com

KGM Industries INC. is a family owned fine jewelry manufacturer base in NYC since 1995. Our highest standards and competitive facilities create quality works of art!

Ken Ghaytanchi
kgmind@aol.com



Lafonn



Booth 27

6721 Katella Ave.
Cypress, CA 90630
714-826-8888 Fax: 714-826-8388
www.LaFonn.com

As a design house and manufacturer, Lafonn is proud to offer our collection of couture sterling silver jewelry. Extravagant handcrafted designs with the world's finest simulated diamonds. Unsurpassed quality and dazzling perfection are the foundation of Lafonn's brilliance and fire.

Steve Binder
Suzanne Markowitz
Linda Coppernoll
info@lafonn.com





P A R A I B A
SIMULATED TOURMALINES

Meticulously crafted in sterling silver bonded with platinum and set with the world's finest simulated diamonds and simulated tourmalines, retailing from \$185.

Lafonn

LUXURY WITHIN REACH

VISIT US:
SELECT SHOW - NATIONAL HARBOR, MD
OCT 14 - 15, BOOTH # 27.
LAFONN.COM • 855-2LAFONN

Leslie's Brand/Quality Gold



Booth 110

500 Quality Blvd.
Fairfield, OH 45014
800-354-9833 Fax: 800-962-4246
www.qgold.com

Leslie's, A premium brand for Quality Gold offers a lifetime guarantee on all gold product. Stock Balancing and Seasonal Dating also available. Please stop by for details.

Pinny Rubin
pinny@qgold.com

LES LIE'S

Lexi Mazz Designs



Booth 207

491 Main Street
Islip, NY 11751
631-793-0206
www.leximazzdesigns.com

LexiMazz Designs, founded in New York, is a revolutionary fine jewelry design company that utilizes a distinctly unique, yet modern style. From her background as a sixth-generation jeweler, the Founder and designer, Alexis Mazza creates sleek lines, chic drapery, and the quality use of gold, diamonds, and semi-precious stones to create a cohesive style of sexiness and sophistication applicable to any situation.

Alexis Mazza
alexis@leximazzdesigns.com



EXHIBITORS

Lika Behar



Booth 16

263 Veterans Blvd. Unit # B
Carlstadt, NJ 07072
201- 933-7200
www.likabehar.com

Lika Behar creates unique and intimate works of wearable art inspired by ancient civilizations & the Mediterranean. Her hand wrought individual designs reflect ancient history, as well as, the modern feminine spirit. She works with 24kt and 22kt gold, oxidized sterling silver, diamonds & a myriad of beautiful gemstones.

Lika Behar
Likabehar@likabehar.com



Luca Lorenzini



Booth 405

2300 E 7th St. #201
Charlotte, NC 28204
800-605-3035 Fax: 704-333-3032
www.wlhlimited.com

Handmade Italian Fine Fashion Jewelry, Luca Lorenzini Featured by Lecil original designs represent a bold fusion of classic and modern Italian design. All natural elements; Sterling Silver with 18kt Vermeil, hand crafted leather and diamond cut White Sapphires. Retail's from \$100-\$990.

Lecil Henderson
generalinfo@wlhlimited.com



EXHIBITORS



Makur



Booth 401

42 West 48th St Ste 1701
New York, NY 10036
212-730-8696
www.makurdesigns.com

The subtle use of color, form and texture is a hallmark of Makur Designs signature collections, including the award-winning Morganite & Rose Gold Collection -- always identifiable through detail and quality.

Arlene Hagopian
makurinfo@yahoo.com



Marathon/LeStage



Booth 21

90 O'Neil Blvd.
Attleboro, MA 02703
508-222-5544 508-226-6272
www.marathon-co.com

The Marathon Company has been manufacturing in the USA since 1897. The brand names Kiddie Kraft and Convertibles are known in the marketplace for superior quality, unique designs, and a lifetime guarantee. Products are made from Gold, Sterling silver, and Gold-filled.

Marathon also manufactures fine ladies' lockets, bracelets, and religious jewelry, and produces sterling silver baby gifts such as cups, rattles, and spoons.

Paul Bottomley
pbottomley@marathon-co.com



CAPE COD JEWELRY®
ESTD LESTAGE 1863

Makur
DESIGNS®



Toll-free: 877-77-MAKUR
makurdesigns.com

Designs © MAKUR DESIGNS®.
All rights reserved. Made in the USA.

Marika Desert Gold



Booth 109

7000 Town Centre Drive #150
 Broadview Heights, OH 44147
 216-759-7569
www.marikadesertgold.com

Marika Desert Gold intertwines nature into each piece highlighting organic color and natural shapes, which complement a women's body. "Marika" blends a mixture of ancient designs from Mediterranean and Middle Eastern goldsmithing cultures creating contemporary, beautiful jewelry inspired to be exotic and appealing to intelligent women with a spirit for adventure.

Paul Vopat
paul@mijbymarika.com

MARIKA
 DESERT GOLD

Mastoloni



Booth 34

415 Madison Ave.
 New York, NY 10017
 800-347-3275
www.mastoloni.com

Mastoloni cultured pearl jewelry and necklaces have adorned women for celebrations, milestones, professional and daily wear for nearly a century. Chosen 'Best in Pearls' by retailers across the country, Mastoloni pearls truly are The Most Beautiful Pearls In The World™.

Ray Mastoloni
raymond@mastoloni.com

Dan Bogue
dan@mastoloni.com

MASTOLONI
The Most Beautiful Pearls In The World™

EXHIBITORS

Mazza & Co



Booth 206

2145 Marion Pl
Baldwin, NY 11510
516-379-4139
www.mazzajewelry.com

For almost two centuries, The Mazza Company has been offering color at it's best! William and his three sons carry on their proud heritage using hand-carved gemstones to create spectacular colored collections with 14kt or 18kt and diamonds.

William Mazza
billmazza@verizon.net

MCE



Booth 301

98 Cuttermill Rd Rm 297 N
Great Neck, NY 11021
516-864-3594

At MCE, We carry a full line of finished Jewelry in rings, earrings, pendants, bracelets, necklaces and much more. Come take a look at our extensive line of close outs in 10kt, 14kt, 18kt, and see for yourself our amazing prices.

Mehran Enayatian
mcecorp@aol.com

MAZZA
THE MAZZA COMPANY

MCE
JEWELRY

Meira T Designs



Booth 202

17 East 48th St., Rm. 401
New York, NY 10036
212-398-0726
www.meiratdesigns.com

In the heart of Manhattan Meira T designs her collection which utilize 14kt and 18kt gold, diamonds, and gemstones.

Meira Tugendhaft
Info@meiratdesigns.com

Midas Chain



Booth 32

50 McDermott Place
Bergenfield, NJ 07621
201-244-1150 Fax: 201-244-1151
www.midaschain.com

Midas Chain is the premier jewelry manufacturer with an extensive array of beautiful styles in the over 500-page catalog. These range from 14kt gold chains to unique fashion forward items that your customer will adore.

Mark Doris
mark@midaschain.com

meiraT

MIDAS®

EXHIBITORS

Michael Michaud Design Four Seasons Design



Booth 302A

Four Seasons Design Group
2400 Merrick Road
Bellmore, NY 11710
516-781-3155, ext. 120

Hand crafted jewelry, cast directly from nature. Stunningly beautiful, collections available in 14K gold and 24K gold over fine silver (for incredible price points), accented with freshwater and keshi pearls and semi-precious gemstones. All manufactured and designed in Long Island, New York.

Steve Feldman
steve@foursdg.com



MWI



Booth 204

35 West 45th St.
New York, NY 10036
212-869-9400 ext 302
www.mwiwloquence.com

MWI Eloquence collections are designed and manufactured to meet strict standards of excellence and provide customers with beautiful heirloom-quality jewelry.

Kerri Sprecher
kks@mwinvy.com

MWI
ELOQUENCE
since 1954

Nava Dee for AOD



Booth 20

62 West 47th St #1508
 New York, NY 10036
 212-719-4121
www.navadee.com

Founded in 1962, AOD Jewelry started and continues to be known as a trusted quality company that surpasses most. Our excellence in exquisite and unique designs, combined with knowledge of rare stones and diamonds, make us a step above the rest.

Elan Aghbashoff
aodjewelers@yahoo.com

Nava Dee
 Collection

Nina Nguyen



Booth 307

1616 17th St., Ste 467
 Denver, CO 80202
 720-459-7664 Fax: 720-836-4608
www.nina-nguyen.com

Nguyen's latest design was recently awarded a patent pending status which covers an element in the new earring collection, and allows these pieces to be transformed for multiple-use, convertible styling. Earrings featured in the collection can individually be turned into a pendant and worn on a necklace, or used as a charm.

Nina Nguyen
nina@nina-nguyen.com

Nguyen
 ninanguyen

EXHIBITORS

Norman Covan



Booth 305

510 W 6th St , #202
Los Angeles, CA 90014
213-488-9144 Fax: 213-622-3859
www.normancovan.com

Norman Covan strives to bring stunning jewelry to the people who appreciate the artistry, quality and workmanship.

Norman Covan
info@normancovan.com

NORMAN COVAN
—  —

Novell



Booth 23

2100 Felver Court
Rahway NJ 07065
888-668-3551
www.novelldesignstudio.com

Made better in America for over 30 years. Novell's award winning designs and state of the art manufacturing bring you the best of the best. Our new Custom Shop division opens our factory up to you, the retailer, for all your design and manufacturing needs so now you can focus more on what's important: your business.

Phil Edelstein
phil@novellgroup.com

Michael Kolesarich
mcolesarich@novellgroup.com

Novell
design studio

Officina Bernardi



Booth 203

390 5th Ave #705
 New York, NY 10018
 212-273-0797 Fax: 212-273-0870
www.officinabernardi.com

Officina Bernardi is an Italian design house and manufacturer with over 30 years of experience in the art of fine jewelry. Their newest collection, Aurora Blue, features natural mother of pearl infused with a gorgeous cerulean blue and highlighted with their signature moon beads.

Katherine Whitacre
katherine@officinabernardi.com

OFFICINA ■ BERNARDI

Paragon Couture Group



Booth 102

2 W 45th St.
 New York, NY 10036
 800-435-8848
www.paragoncouture.com

Paragon introduces the Equinox Gold Collection for Men, a trendsetting collection designed to reinforce a daring and unique statement. Our designs incorporate bold motifs that project masculinity and confidence. Proudly manufactured in the US.

Ben Davoodzadeh
ben@paragoncouture.com



PARAGON
 HANDCRAFTED IN
 NEW YORK

EXHIBITORS

Parle



Booth 30

1775 South 5th Ave.
Pocatello, ID 93201
800-635-9800 Fax: 208-233-0120
www.parlegems.com

Parlé means to speak and that sentiment encompasses each piece of jewelry we handcraft. We believe beautiful jewelry is created when there is a flow and relationship between metal and gemstone. Our dedication ensures that Parlé Jewelry is sourced from the mine with care, thoughtfully designed and meticulously crafted so it will be enjoyed for lifetimes.

Jonathan Farnsworth
parlegems@parlegems.com

Parlé

PeJay



Booth 309

150 Meadowlark Parkway
Secaucus, NJ 07094
201-863-0006 Fax: 201-863-0067
www.pejaycreations.com

Since 1950, we have been dedicated to consistent quality and service, never taking our customers for granted. Collections range from our classic diamond designs to our fashion forward use of textures and color. Our customers are as precious to us as the jewelry we manufacture.

Mitchell Feuer
mitchell@pejaycreations.com

PEJAY
CREATIONS

Bridal Collection

by VARIETY GEM

Since 1984



Booth #28

 **VARIETY GEM Co., inc.**

800-735-4367 * WWW.VARIETYGEM.COM

Rembrandt Charms®

Precious charms for precious memories.

Show Silver. Sell Gold!

How would your business look today, if our smallest floor display had been cultivating over 400 new and repeat customers annually?

- Rembrandt's charm displays generate \$4,500 - \$7,500 in sales per square foot!
- Complete selection of inventory-controlled displays available. Re-order only what you sell!
- Our vertical displays contain the best-selling charms by region, leading to impulse Sterling Silver sales and Karat Gold special orders.
- Our charm collectors are loyal repeat customers!

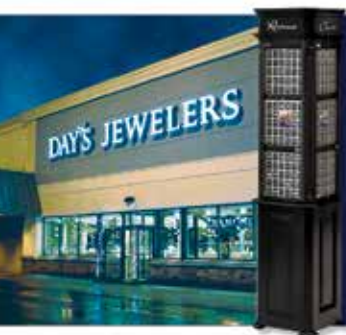

What Retailers Are Saying

"Rembrandt's Program has been a success for our stores for over 35 years! They provide us with an array of creative and timely marketing support for our digital and print advertising strategies, as well as in-store POS materials, such as mini-catalogs for customers, window graphics, videos, and duratrans."

- Kathy Corey, Day's Jewelers

Contact us for more info on our Business Building Charm Program!

Orders@RembrandtCharms.com • p.800-828-7840 • f.800-828-7811



Lifetime
Warranty



Handcrafted in
USA & Canada



Thousands of Charms
in Gold and Silver

EXHIBITORS



Phillip Gavriel



Booth 15

2 West 46th St.
New York, NY 10036
www.phillipgavriel.com

Phillip Gavriel creates fine jewelry for today's modern lifestyle, with handcrafted pieces in silver, gold, and precious gemstones. The collection has wide scale appeal with retail prices in gold starting at \$220. These bangles in silver and diamonds or black spinel start at \$695.

Kam Melamed
kam@royalchain.com



Qayten



Booth 107

510 W 6th St Ste 416
Los Angeles, CA 90014
213-624-2277
www.qayten.net

Qayten is the house of the creativity where aesthetics, technical innovation and cutting-edge designs blend together while honoring the traditional techniques for an ever-wearable contemporary jewellery.

Maddalena Allefretti
maddalena@qayten.net





ROYAL

www.royaljewelry.com
212.302.2500



DIAMONDS FOREVER

USA

www.dfeusa.com | 516.466.1900

Reko Settings



Booth 206

333 Washington St., Ste. 851
Boston, MA 02108
617-367-8960 Fax: 617-367-2626
www.rekosettings.com

Reko Settings offers large selection of engagement rings, matching bands- Novel Collection with gemstones is a fine collection of earrings, pendants and rings. Custom creation with precious stone accents is offered with no model making charges.

Sam Mulani
sam@rekoinc.com

Rak Adhikari, Garry Wallace



Rembrandt Charms



Booth 17

370 S Young's Rd.
Willamsville, NY 14221
www.rembrandtcharms.com

Rembrandt Charms is a family owned company that designs and manufactures charms and charm bracelets. All Rembrandt Charms merchandise is made entirely in the United States and Canada and is covered by our Lifetime Warranty. Rembrandt offers thousands of charms in gold and silver, including over 200 movable charms.

Megan Ciarfella
mciarfella@rembrandtcharms.com



EXHIBITORS



Royal Chain

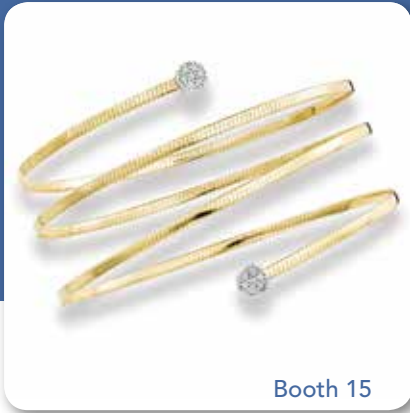

Booth 15

2 West 46th St.
New York, NY 10036
212-382-3340 Fax: 212-730-7616
www.royalchain.com

Royal Chain is the industry's leader in gold. Celebrating their 40th anniversary this year, they have created a commemorative collection featuring the best in gold artistry. Their other areas of expertise include silver, the nationally recognized brand Phillip Gavriel, and other trend products.

Kamran Melamed
kam@royalchain.com

Royal Jewelry/ Diamonds Forever



Booth 18

825 Northern Blvd.
Great Neck, NY 11021
212-302-2500 Fax: 212-768-0601
www.royaljewelry.com

Royal Jewelry has three generations of experience in the gem and jewelry trade. Royal's designs, superb craftsmanship, and astonishing value are known throughout the world. Our line of timeless pieces encompasses classic and fashion-forward designs.

Michael Hakimian
michael@royaljewelry.com



EXHIBITORS



Samuel B.



Booth 408A

98 Cuttermill Rd.
Suite 234 South
Great Neck, NY 11021
855-SamueB
www.Wholesale.SamuelB.com

Samuel Behnam is an award-winning New York based jewelry designer and founder of the Samuel B. Collection. Inspired by the immeasurable beauty of nature and the ancient traditions of Balinese and Thai jewelry craftsmanship, Samuel has made designing stunning jewelry his life's work.

Mathew Behnam
Mathew@SamuelB.com

SAMUEL B.
New York • Bali

Shefi Diamonds Inc.

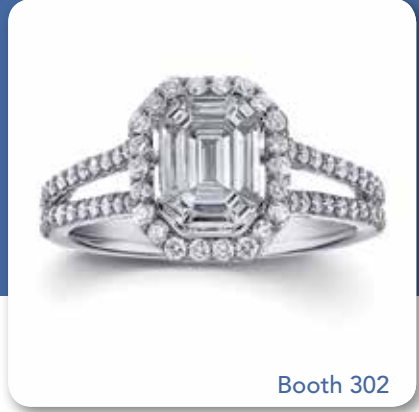

Booth 302

580 Fifth Ave., Ste. 1227
New York, NY 10036
212-391-1482
www.shefidiamonds.com

Shefi Diamonds, featuring our new must-see Bridal Display Program. Shefi provides diamond anniversary bands, bracelets, bangles, solitaires, stud earrings and more - all in free display elements. From basic to exceptional, see Shefi Diamonds.

Sanjay Hirawat
info@shefidiamonds.com



RADIANCE

by VARIETY GEM

Since 1984



Displays ARE AVAILABLE

Booth #28

 VARIETY GEM Co., INC.

800-735-4367 * WWW.VARIETYGEM.COM

Shieler Trading Corp

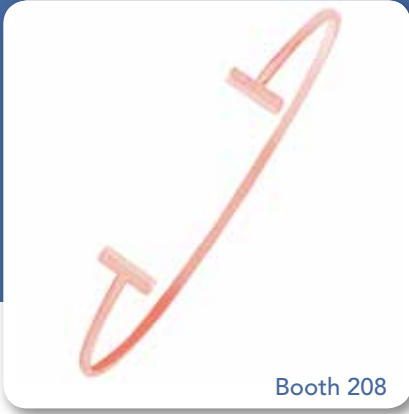

Booth 208

2 West 46th Street, Ste., 509
New York, NY 10036
212-764-7600
www.shieler.com

Shieler Trading Corporation strives on the fact that we put our customer first and we are not happy unless our customers are happy. Our proven quality and price points are here to stay and everyone is family to us. Come join the Shieler Trading Corporation family and our 40 years of tradition and see what all the fuss is about!

Abraham Neissani, abe@shieler.com
Morris Neissani, morris@shieler.com



Variety Gem

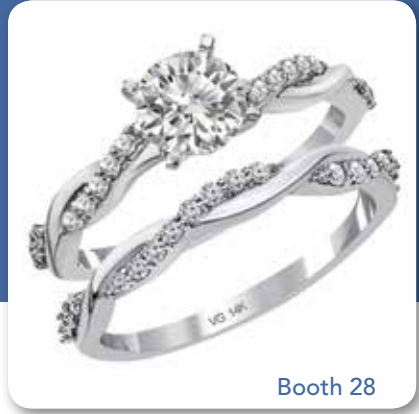

Booth 28

295 Northern Blvd. Ste. 208
Great Neck, NY 11021
800-735-4367 Fax: 212-921-1834
www.varietygem.com

Variety Gem presents these two classic styles price point engagement and matching wedding band for the millennial bride. The engagement ring has 0.16ctw of diamonds and the matching wedding band has 0.19ctw of diamonds. Style number EN2496W/D MSRP \$1,275 and WB2496W/D MSRP \$1,240.

Moshe Bezalel
moshe@varietygem.com



DAVID [®] RAPHAEL

COLLECTION

by Shieler Trading Corporation

since 1979

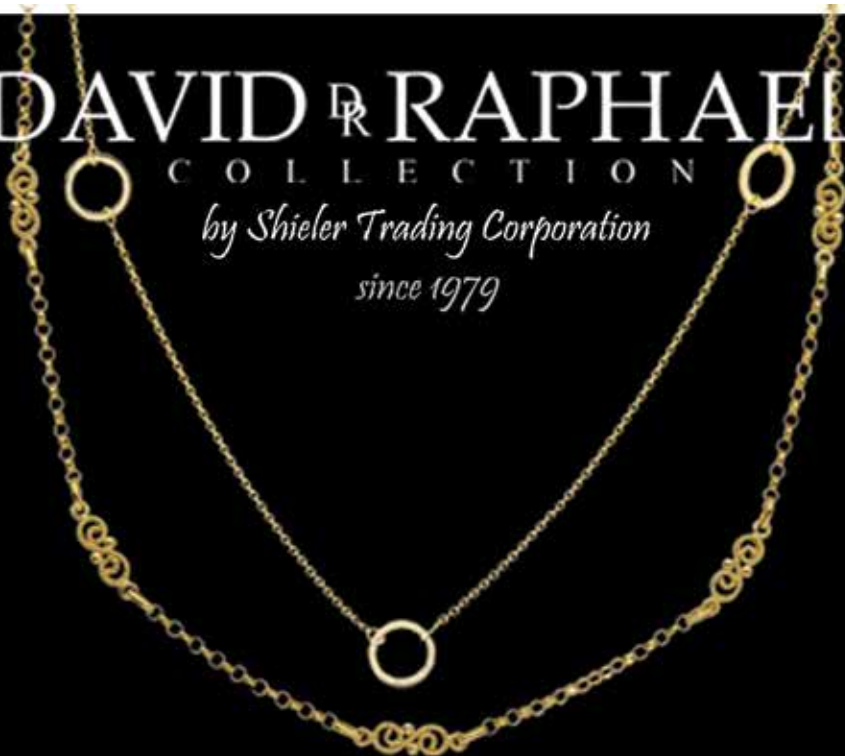

Shieler Trading Corporation

800-421-2346 • shieler.com



Lustour R

Eternal Fire

Lustour is lab-created marvel that surpasses any stone in brilliance, beauty, & luster. Each stone is hand cut to perfection almost always flawless & colorless (D,E,F colors)



\$695/ct MSRP



HEARTS



ARROWS

*Lustour comes
with a Lifetime Warranty!*

Lustour R Premium

- Tests positive as a Diamond on Thermal diamond testers
- Carbon Infused to create similar properties to a mined diamond
- G-H Color



\$975/ct MSRP



Dollar for Dollar Stock Balancing Across All Our Lines

www.Lustour.com
sales@AiyaDesigns.com | 888-427-8886

SHOW SPECIALS

Royal Jewelry

Memo Selection

For new customers only, visit us to receive full memo product with no commitments, only pay for what you sell

Aiya Designs

Free Bracelet

Please stop by to get a free Promo PiyaRo bracelet. No purchase necessary!

Leslie's Brand of Quality Gold

Seasonal Dating Program

Order a minimum of \$3,000 with payment due January 10, 2019. Lifetime Guarantee/Stock Balance.

Shefi Diamonds

Save 10%

10% Off all purchases made during the Foxwood Select Show by new customers.

Lika Behar

Save 5% or January Dating

Save 5% on confirmed orders at the show, or enjoy January dating.

Royal Chain

Holiday Dating

Get half 60 /half 90 day payment terms on all orders placed at the show.

Nina Nguyen Designs

Free Gift with Purchase

Visit us to get your winning earring combination system for your store. Free Gift with Purchase promotion when mention this ad.

Shefi Diamonds

Memo & Display

Purchase white gold Anniversary Band Series: receive yellow gold version of same style on memo for one year. Free display elements provided.

Bassali Jewelry Co.

January Dating

Diamond Pave Disc Necklace and Earring Set in 14K gold for \$499. January 2019 Dating on all Orders!

CG Creations (Wind & Fire)

Free Gift just for visiting.

Special pricing on 14K Gold Chain, Earrings, Religious Pendants and of course January dating options.

Meira T

Free Meira T Handbag

Free Meira T handbag with purchase of \$8,000 or more. Handpainted by our in house artist.

Costar Imports

Matching Memo Program with January Dating

on all orders at the Select Show! Visit us and check our Excellent Collection of Stackable & Wedding Bands, Vintage Bridals and Complete Bridal Sets with 1/4-3/4 ct. Centers.

Rembrandt Charms

Small Charms, Big Sales

Is your Charm Program setup for success? Our smallest floor display cultivates over 400 new & repeat customers annually and \$5,500 in sales per square foot! Extended Terms, New Charm Displays, Upgrades and Refreshes!

Brevani, division of Color Merchants

Free Display & Marketing

Receive a free video display, targeted Facebook advertising and marketing with the purchase of Spryngs.

Elite Designs

Save 20%

Discount of 20% on a special group of jewelry

Shefi Diamonds

January Dating

January dating for all purchases finalized during the Foxwood Select Show.

Royal Chain

New Earring Display

Get a complimentary gorgeous gold toned in-case earring display with your purchase of any 30 gold earrings.

H.J. Namdar

Discount & January Dating

An Extra 20% Discount on all colored diamonds Jewelry purchased at the Select Show with January 2019 Dating! (Terms: One payment in 6 months/ 180 Days Terms).

KGM Industries

Save 10%

10% off our vast selection of color stone jewelry.



64 W 48th St., Ste 1005
New York, NY 10036

REGISTER TODAY
844-285-1103

www.selectjewelryshow.com

Excellence Redefined